

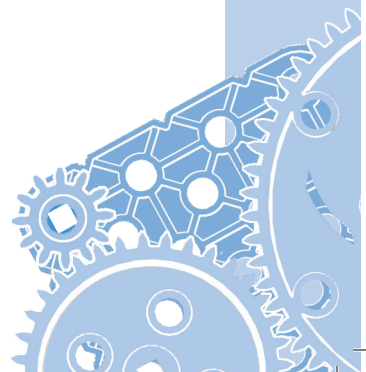

Foundation Add-on Kit

User Guide



Kit Hardware Overview:

If you can imagine it, you can build it with VEX IQ. Here's an overview of common part types and their primary designed functions to help you get started.

Common part types and primary functions

<p>Beams various sizes</p>	<p>Specialty Beams angle, tee, right-angle beams</p>	<p>Plates various sizes</p>
		
<p>Structural parts.</p>	<p>Structural parts.</p>	<p>Structural parts.</p>
<p>Connector Pins several lengths</p>	<p>Standoffs several lengths</p>	<p>Standoff Connectors several types</p>
		
<p>Use with beams, plates, corner connectors, and more.</p>	<p>Maintain desired spacing between beams and plates.</p>	<p>Connect standoffs and connector pins.</p>
<p>Corner Connectors several types</p>	<p>Shaft several lengths</p>	<p>Shaft Bushing</p>
		
<p>Create corner connections between beams, plates, or other VEX IQ parts.</p>	<p>Transmit power to, or allow rotation of, wheels, pulleys, gears, and more.</p>	<p>Interfaces shafts with beams and plates, allowing the shaft to spin and be held in desired location.</p>

Shaft Lock Plates multiple sizes	Rubber Shaft Collars	Twist Lock Shaft Collars
		
Plates that lock onto shafts allowing design components to spin with the shaft.	Holds objects on shafts and/or the shaft itself in place.	Holds objects on shafts and/or the shaft itself in place.
Washers & Spacers	Pulleys several options	Rubber Belts several size options
		
Use with shafts, reduces friction and maintains desired spacing.	Drive belts or make rollers and small wheels.	Use with pulleys, as a form of stored energy, and/or as a fastener.
Rubber Band Anchor	Turntable several options	Wheel hubs and tires several size options
		
Use with rubber belts and bands.	Use to create high strength rotational joints.	Rolling and powering movement.

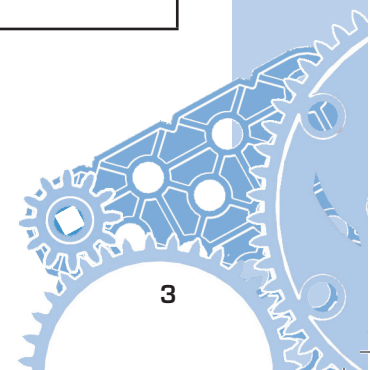

VEX IQ Kit Hardware Tips:

Removing Connector Pins

To remove connector pins from structural components, gently push the pin with your finger from the back of the structural components to free it slightly, then it will be easier to pull it out. Alternatively, a shaft can be used instead of a finger to push the pin from the back.

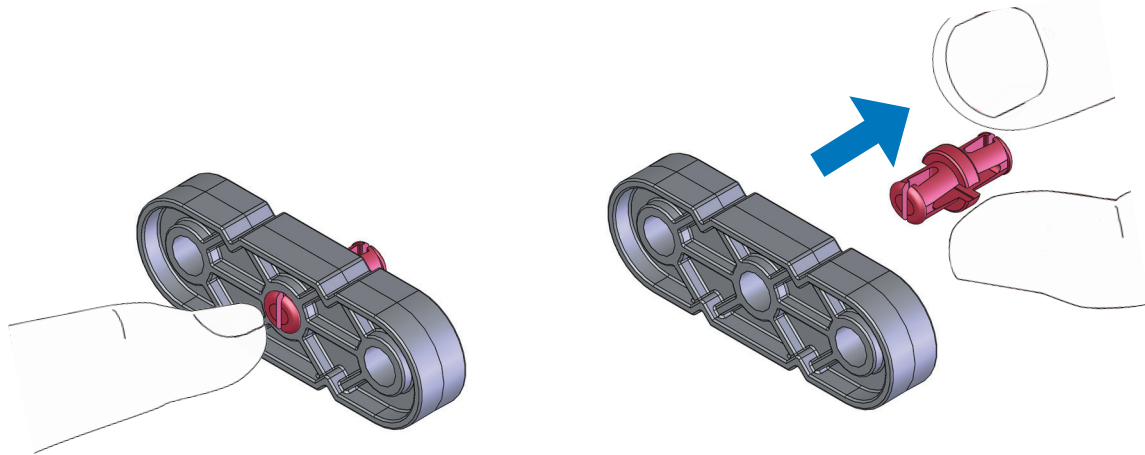

Fitting Small Gears, Pulleys, and Wheel Hubs onto Shaft

VEX IQ shafts are built to last and run flawlessly in powered applications. Gears, pulleys, and wheel hubs fit very tightly on the VEX IQ shaft to ensure quality mechanisms with minimal amounts of “wobble”. Because of the intentionally tight fit, sliding smaller gears, pulleys, and wheel hubs can be tough for some users. To help in this process, insert the shaft into a large wheel hub (which acts as a temporary stand), then use the leverage from a beam or plate to push the smaller gear, pulley, or wheel hub to the desired place. Then the temporary stand can be removed and the shaft with small gears, pulleys, or wheel hubs can be mounted on its mechanism.

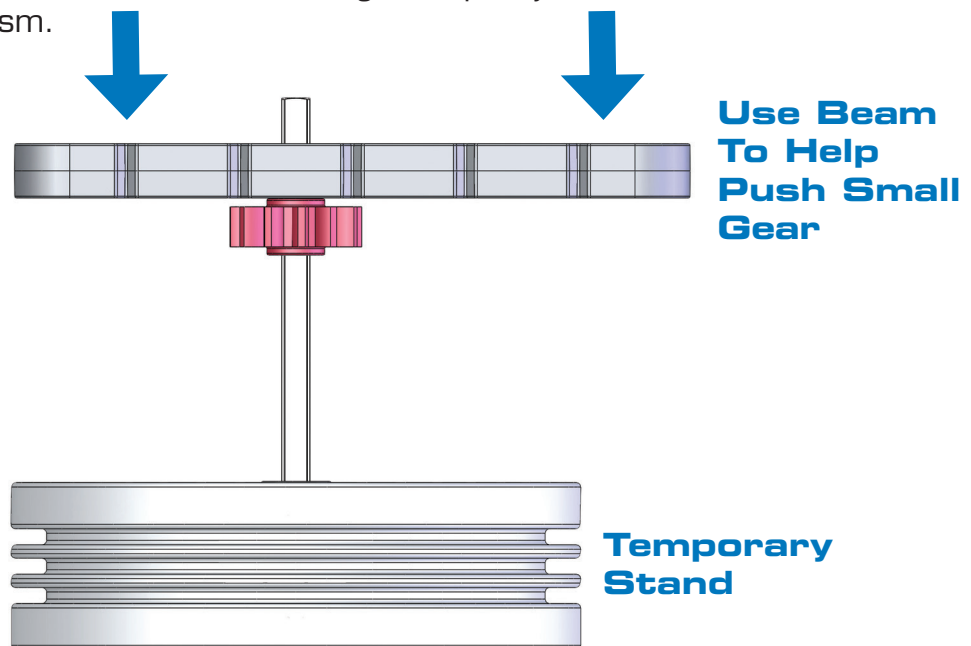

Keeping the Shaft Supported & Seated in Smart Motors & Assemblies

Having a motor turn a shaft in the VEX IQ system is accomplished easily with only a few parts. However, without proper shaft support and either a rubber shaft collar and/or a shaft bushing, the shaft will quickly shift or fall out of your mechanism or Smart Motor.

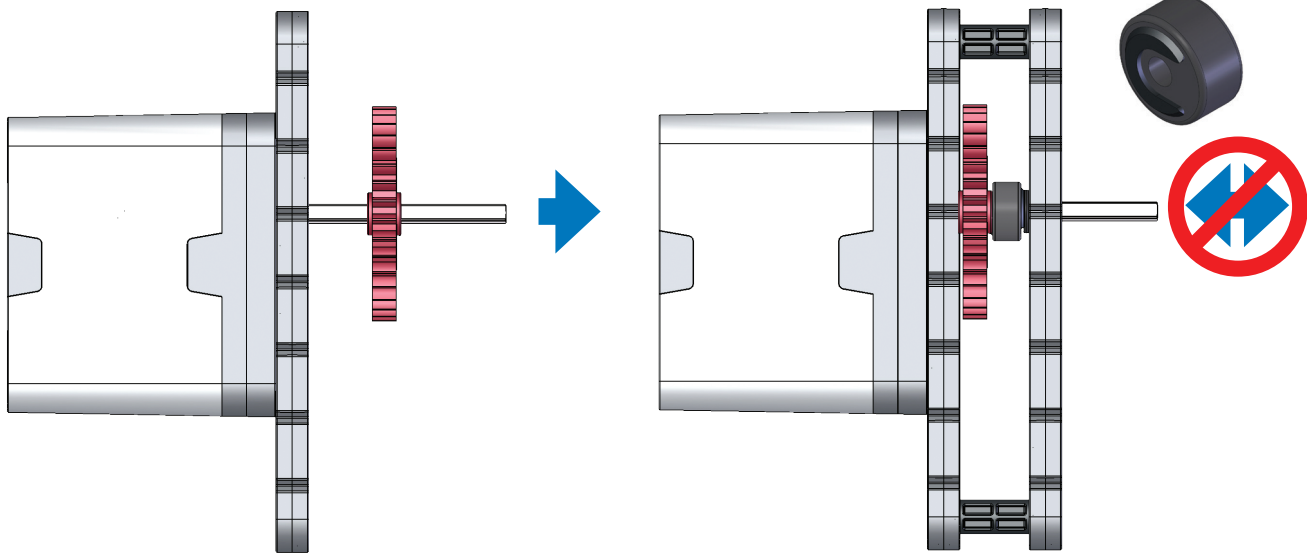

**Improper Support
(Shaft can fall out)**

**Proper Support
(Shaft can't fall out)**

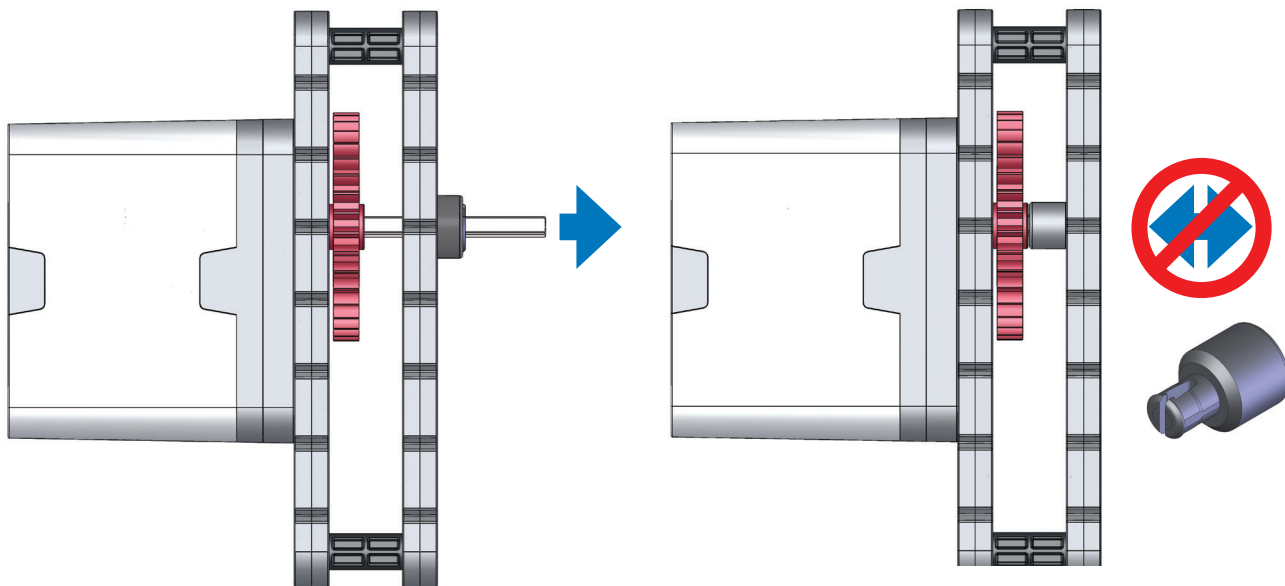

**Improper Support
(Shaft can fall out)**

**Proper Support
(Shaft can't fall out)**

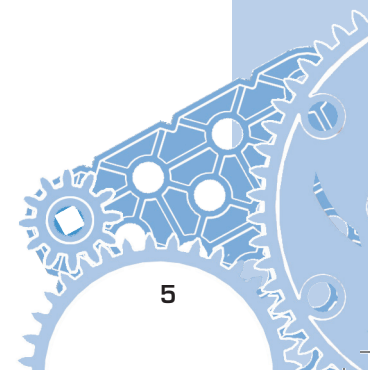

KIT Quantities

VEX IQ Structural Add-On Kit

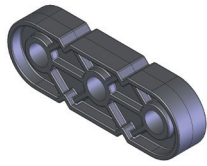

1x3 Beam
(4x)

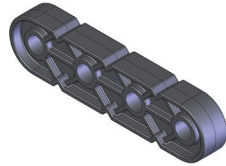

1x4 Beam
(10x)

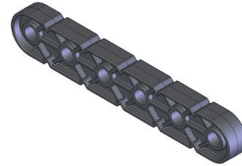

1x6 Beam
(10x)

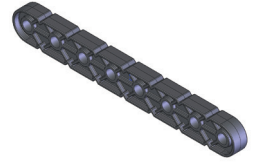

1x8 Beam
(12x)

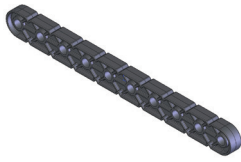

1x10 Beam
(10x)

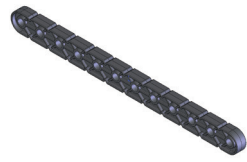

1x12 Beam
(6x)

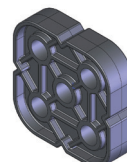

2x2 Beam
(8x)

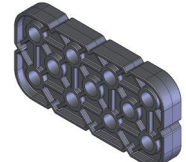

2x4 Beam
(8x)

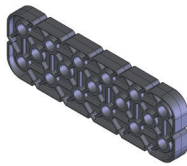

2x6 Beam
(8x)

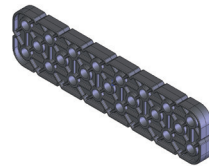

2x8 Beam
(8x)

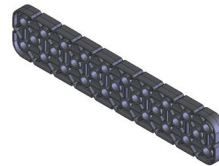

2x10 Beam
(6x)

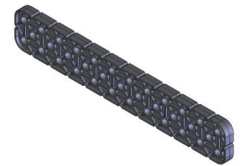

2x12 Beam
(8x)

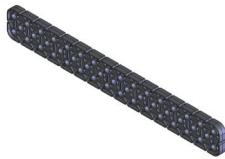

2x16 Beam
(8x)



2x20 Beam
(4x)

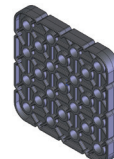

4x4 Plate
(4x)

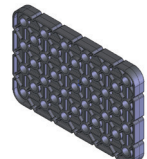

4x6 Plate
(4x)

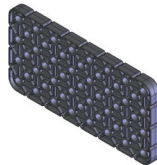

4x8 Plate
(4x)

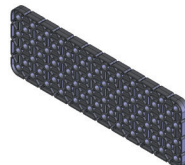

4x12 Plate
(4x)

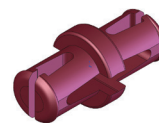

1x1 Connector Pin
(240x)

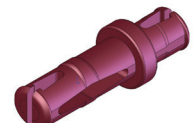

1x2 Connector Pin
(60x)

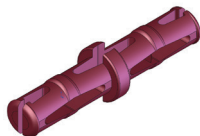

2x2 Connector Pin
(20x)

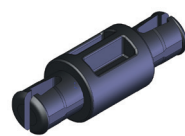

1/2x Pitch Standoff
(12x)



1x Pitch Standoff
(12x)

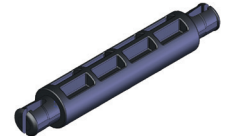

2x Pitch Standoff
(12x)

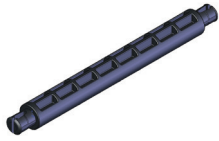

4x Pitch Standoff
(12x)

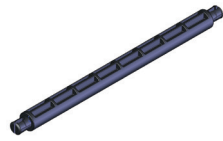

6x Pitch Standoff
(12x)



Shaft Washer
(40x)

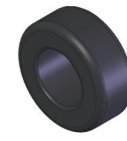

1/4x Pitch Shaft Spacer
(50x)

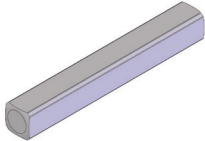

2x Pitch Shaft
(6x)

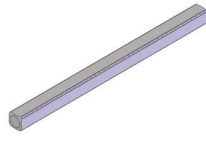

4x Pitch Shaft
(6x)

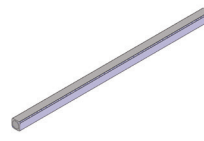

6x Pitch Shaft
(6x)

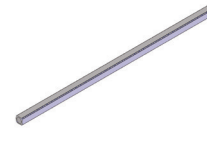

8x Pitch Shaft
(6x)

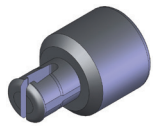

Shaft Bushing
(10x)

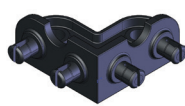

Large Chassis Corner Connector
(15x)

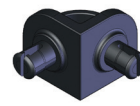

Small Chassis Corner Connector
(30x)

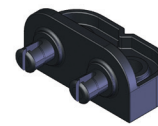

2x Wide, 1x2 Corner Connector
(15x)

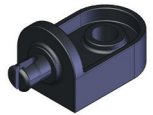

1x Wide, 1x1 Offset Corner
Connector
(20x)

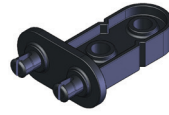

2x Wide, 2x1 Offset Corner
Connector
(12x)

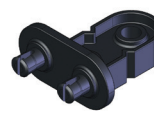

2x Wide, 2x1 Corner Connector
(12x)

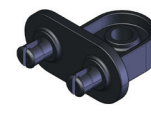

2x Wide, 1x1 Offset Corner
Connector
(12x)

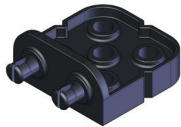

2x Wide, 2x2 Corner Connector
(20x)

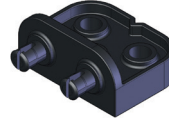

2x Wide, 1x2 Offset Corner
Connector
(20x)

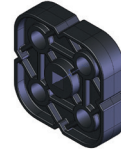

2x2 Shaft Lock Plate
(8x)

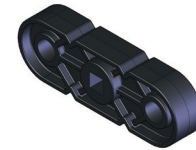

1x3 Shaft Lock Plate
(8x)

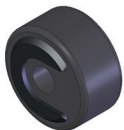

Rubber Shaft Collar
(60x)

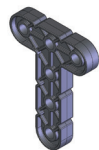

3x4 Tee Beam
(8x)

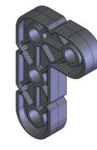

2x3 Right Angle Beam
(8x)

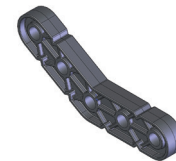

30 Degree Angle Beam
(8x)

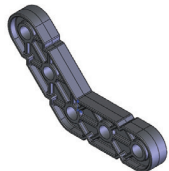

45 Degree Angle Beam
(8x)

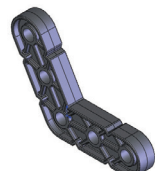

60 Degree Angle Beam
(8x)

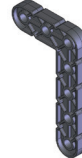

3x5 Right Angle Beam
(8x)



4x4 Offset Right Angle Beam
(8x)

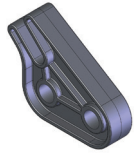

Rubber Band Anchor
(6x)

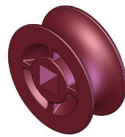

10mm Diameter Pulley
(2x)

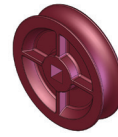

20mm Diameter Pulley
(2x)



30mm Diameter Pulley
(2x)



40mm Diameter Pulley
(2x)

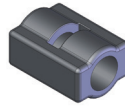

Mini Standoff Connector
(24x)

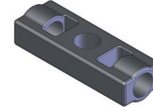

Straight Standoff Connector
(12x)

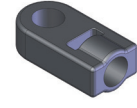

End Standoff Connector
(16x)

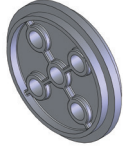

Small Turntable Center Bushing
(3x)



Small Turntable Outer Housing
(6x)

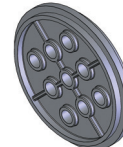

Large Turntable Center Bushing
(2x)

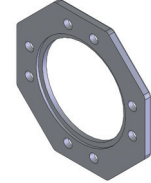

Large Turntable Outer Housing
(4x)



100mm Travel Rubber Tire
(2x)



30mm Rubber Belt
(2x)



40mm Rubber Belt
(2x)



50mm Rubber Belt
(2x)



60mm Rubber Belt
(2x)

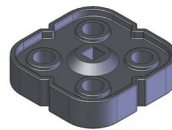

Inner Twist Lock Shaft Collar
(8x)

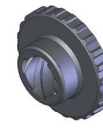

Outer Twist Lock Shaft Collar
(8x)

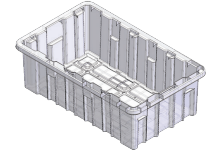

Storage Bin
(1x)

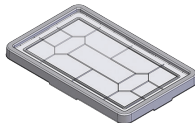

Storage Lid
(1x)

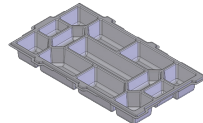

Storage Tray
(1x)

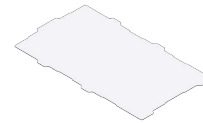

Storage Tray Divider
(1x)

Copyright and Trademark Notice

©2013 VEX Robotics, Inc. All rights reserved. Patent(s) Pending. VEX, VEX IQ, and VEX Robotics are trademarks or service marks of Innovation First International, Inc. All other product trademarks referenced herein belong to their respective companies.



⚠ **Warning:** CHOKING HAZARD – Small parts.
 ⚠ **Avertissement:** RISQUE D'ASPHYXIE – Ce produit contient de petits éléments.
 ⚠ **Advertencia:** RIESGO DE ASFIXIA – Contiene piezas pequeñas.
 ⚠ **Achtung:** ERSTICKUNGSGEFAHR – Kleinteile.
 ⚠ **Attenzione:** RISCHIO DI SOFFOCAMENTO – Pezzi piccoli.

Ages 8+
Ans 8+

⚠ WARNING:
CHOKING HAZARD - Small parts.
 Not for children under 3 years.

⚠ AVERTISSEMENT:
RISQUE D'ÉTOUFFEMENT -
 Comporte de petites pièces. Ne convient pas aux enfants de moins de 3 ans.

Custom manufactured in China for Innovation First Trading, Inc./Produit fabriqué en Chine pour Innovation First Trading, Inc.. Distributed in the U.S.A. by VEX Robotics, Inc., 1519 Interstate 30 West, Greenville, Texas 75402, U.S.A. Distributed in Europe by Innovation First Trading, Inc., 6 Melford Court, Hardwick Grange, Warrington UK WA1 4RZ (44) (0) 1925 453144. Distributed in Canada by/Distribué au Canada par/Innovation First Trading, Inc., 1519 Interstate 30 West, Greenville, Texas 75402, U.S.A. ©2013 VEX Robotics, Inc. All rights reserved. Patent(s) Pending. All other product names referenced herein are trademarks of their respective companies. ©2013 VEX Robotics, Inc. Tous droits réservés. En attente de brevet. Tout les autres noms de produit référencés ici sont les marques déposées des sociétés respectives.